

II B.Tech I Semester Supplementary Examinations, November 2008
ENGINEERING MECHANICS
(Chemical Engineering)

Time: 3 hours

Max Marks: 80

Answer any FIVE Questions
 All Questions carry equal marks

- Two forces equal to $2P$ and P respectively act on a particle. If first be doubled and the second increased by 12N the direction of the resultant is unaltered, find the value of 'P'?
 - A 675 N man stands on the middle rung of a 225 N ladder, as shown in Figure 1b. Assuming a smooth wall at B and a stop at A to prevent slipping, find the reactions at A and B. [8+8]

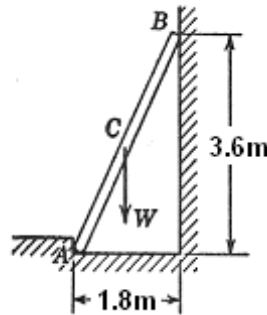

Figure 1b

- A 108 N block is held on a 40° incline by a bar attached to a 150 N block on a horizontal plane Figure 2a. The bar which is fastened by smooth pins at each end, is inclined 20° to the horizontal. The co-efficient of friction between each block and its plane is 0.325 . For what horizontal force P , applied to 150 N block will motion to the right be impending?

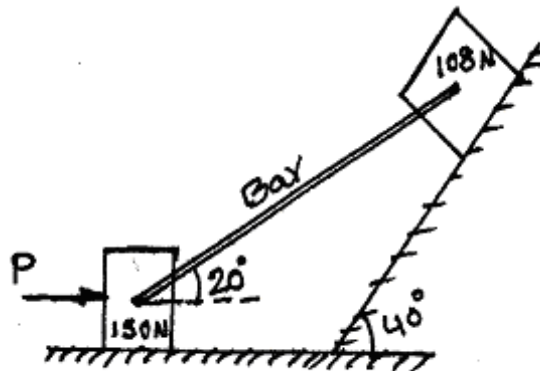

Figure 2a

- A block weighing 100 N is resting on a rough plane inclined 20° to the horizontal. It is acted upon by a force of 50N directed upward at angle of 14°

above the plane. Determine the friction. If the block is about to move up the plane, determine the co-efficient of friction. [10+6]

3. (a) Deduce an expression for centrifugal tension of belt drive.
 (b) The maximum allowed tension in a belt is 1500 N. The angle of lap is 170° and coefficient of friction between the belt and material of the pulley is 0.27. Neglecting the effect of centrifugal tension, calculate the net driving tension and power transmitted if the belt speed is 2 m/s. [6+10]
4. (a) Differentiate between centroid and center of gravity.
 (b) Determine the product of inertia of shaded area as shown in Figure 4b about the x-y axis. [6+10]

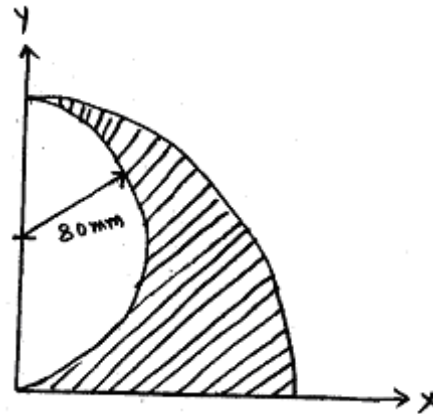

Figure 4b

5. Derive the expression for the moment of inertia of a cylinder length ' l ', radius ' r ' and density ' w ' about longitudinal centroidal axis and about the centroidal transverse axis. [16]
6. (a) A body moves along a straight line and its acceleration ' a ' which varies with time ' t ' is given by $a = 2 - 3t$. Five seconds after the start of observation, the velocity is 20 m/s. The distance moved by the body 10sec after the start of observation of motion from origin is 85 m
 Determine
 - i. the acceleration, velocity and distance from the origin at the start of observation.
 - ii. the time after the start of observation at which the velocity becomes zero and the distance travelled from the origin.
- (b) A car is uniformly accelerated and passes successive kilometre-stones with velocities of 20km/hour and 30km/hour respectively. Calculate its velocity when it passes the next kilometre stone and the time taken for each of these two intervals of one kilometre. [8+8]
7. (a) A homogeneous sphere of radius of $a=100$ mm and weight $W=100$ N can rotate freely about a diameter. If it starts from rest and gains, with constant angular acceleration, an angular speed $n=180$ rpm, in 12 revolutions, find the acting moment. .

- (b) A block starts from rest from 'A'. If the coefficient of friction between all surfaces of contact is 0.3, find the distance at which the block stop on the horizontal plane. Assume the magnitude of velocity at the end of slope is same as that at the beginning of the horizontal plane.

As shown in the Figure7b

[8+8]

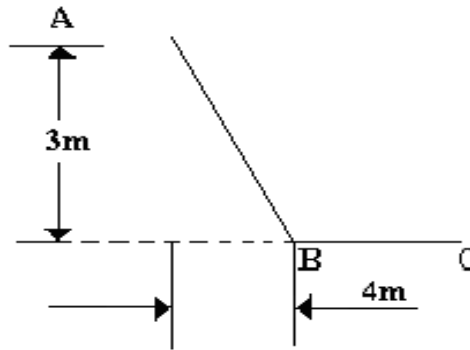

Figure 7b

8. A centrifugal pump rotating at 400 rpm is driven by an elastic motor at 1200 rpm through a single stage reduction gearing. The moment of inertia of the pump impeller at the motor are 1500 kg.m^2 and 450 kg.m^2 respectively. The lengths of the pump shaft and the motor shaft are 500 and 200 mm, and their diameters are 100 and 50 mm respectively. Neglecting the inertia of the gears, find the frequency of torsional oscillations of the system. $G = 85 \text{ GN/m}^2$. [16]

II B.Tech I Semester Supplementary Examinations, November 2008
ENGINEERING MECHANICS
(Chemical Engineering)

Time: 3 hours

Max Marks: 80

Answer any FIVE Questions
 All Questions carry equal marks

1. Find the reactions R_a and R_b induced at the supports A and B of the right angle bar ACB supported as shown in Figure 1 and subjected to a vertical load P applied at the mid-point of AC. [16]

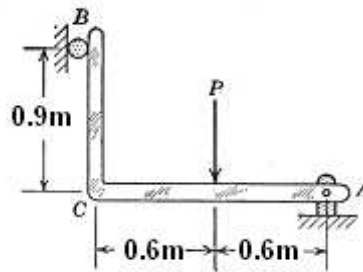

Figure 1

2. (a) A 108 N block is held on a 40° incline by a bar attached to a 150 N block on a horizontal plane Figure 2a. The bar which is fastened by smooth pins at each end, is inclined 20° to the horizontal. The co-efficient of friction between each block and its plane is 0.325. For what horizontal force P, applied to 150 N block will motion to the right be impending?

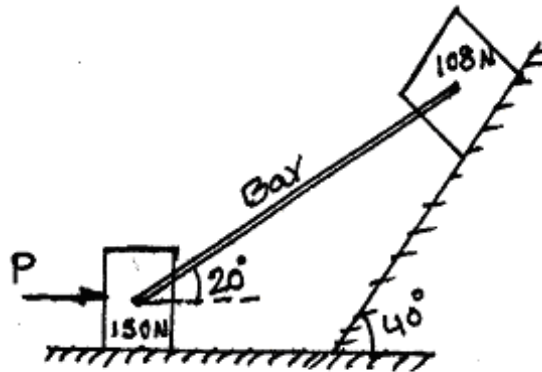

Figure 2a

- (b) A block weighing 100 N is resting on a rough plane inclined 20° to the horizontal. It is acted upon by a force of 50N directed upward at angle of 14° above the plane. Determine the friction. If the block is about to move up the plane, determine the co-efficient of friction. [10+6]
3. Power transmitted between two shafts 3.5 m apart by a crossed belt drive round two pulley, 600 mm and 300 mm in diameters is 6KW. The speed of the larger

pulley is 220 r.p.m. The permissible load on the belt is 25 N/mm width of the belt which is 5 mm thick. The coefficient of friction between the smaller pulley surface and the belt is 0.35.

Determine:

- (a) Necessary length of the belt
- (b) The width of the belt, and
- (c) The necessary initial tension in the belt. [16]

4. (a) Explain the transfer formula for product of inertia
- (b) Find the moment of inertia for the shaded area parallel to x – axis. As shown in the Figure4b. [6+10]

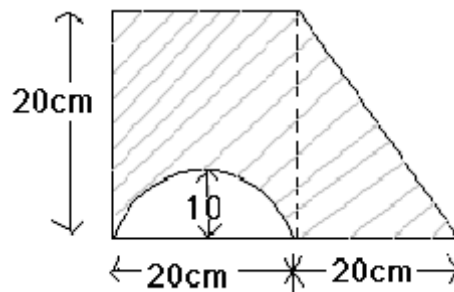

Figure 4b

5. A rectangular parallelepiped has the following dimensions.
 Length along x-axis = 'l'
 Height along y-axis = 'a'
 Breadth along z-axis = 'b'
 Density of the material is 'w'
 Determine the mass moment of inertia of the parallelepiped about the centroidal axes. [16]
6. (a) A small grinding wheel is attached to the shaft of an electric motor which has a rated speed of 3000r.p.m . When the power is turned on, the unit reaches its rated speed in 5secs and when the power is turned off, the unit comes to rest in 60secs. Assuming the acceleration to be uniform, find the number of revolutions that the motor executes
 - i. in reaching its rated speed and
 - ii. to come to rest.
- (b) A cord is wrapped around a wheel which is initially at rest as shown in figure6b. Force is applied to the cord and is gives an acceleration $a=6t \text{ m/s}^2$ where t is in seconds. Determine
 - i. The angular velocities of the wheel
 - ii. The angular position of radial line OP as a function of time. [8+8]

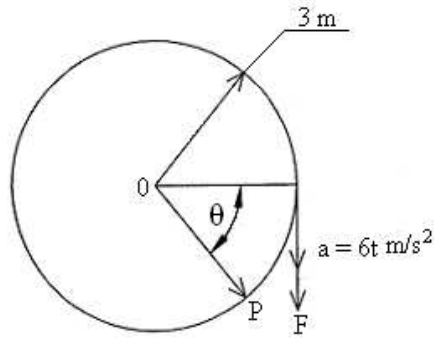

Figure 6b

7. (a) A weight 'P' attached to the end of a flexible rope of diameter $d=5\text{mm}$, is raised vertically by winching the rope on a reel. The reel is turned uniformly at the rate of 2 revolutions per second. Find the tension in the rope. Neglect the inertia of the rope and the lateral motion of the weight 'P'. As shown in the Figure 7a.

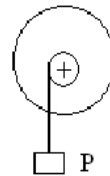

Figure 7a

- (b) A right circular cylinder of radius 'r' and weight 'W' is suspended by a cord that is wound around its surface. If the cylinder is allowed to fall, prove that the center of gravity 'C' will follow a vertical rectilinear path and find the acceleration ' a_c ' along this path. Determine also the tensile force 'S' in the cord. As shown in the Figure 7b. [8+8]

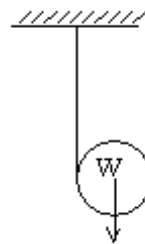

Figure 7b

8. A pendulum having a time period of 1 sec. is installed in a lift. Determine its time period when
- the lift is moving upwards with an acceleration of $\frac{g}{10}$.
 - the lift is moving downwards with an acceleration of $\frac{g}{20}$.

II B.Tech I Semester Supplementary Examinations, November 2008
ENGINEERING MECHANICS
(Chemical Engineering)

Time: 3 hours

Max Marks: 80

Answer any FIVE Questions
 All Questions carry equal marks

1. Determine the resultant of the four forces and one couple that act on the plate as shown in Figure 1. [16]

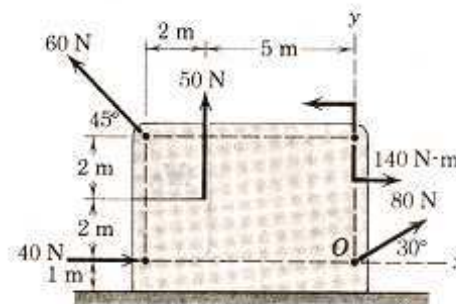

Figure 1

2. (a) Define the following:
- i. Friction
 - ii. Angle of friction
 - iii. Limiting friction
 - iv. Cone of friction
- (b) A ladder 5 m long and of 250 N weight is placed against a vertical wall in a position where its inclination to the vertical is 30° . A man weighing 800 N climbs the ladder. At what position will he induce slipping? The co-efficient of friction for both the contact surfaces of the ladder viz. with the wall and the floor is 0.2. [8+8]
3. (a) Derive an expression for length of an open belt in standard form.
- (b) A belt is running over a pulley of diameter 1200 mm at 200 r.p.m. The angle of contact is 165° and coefficient of friction between the belt and pulley is 0.3. If the maximum tension in the belt is 3000 N, find the power transmitted by the belt. [6+10]
4. (a) Define the terms centroid, moment of inertia and radius of gyration.
- (b) Compute moment of inertia of hemisphere about its diametral base of radius 'R'. [6+10]
5. (a) Define mass moment of inertia and explain Transfer formula for mass moment of inertia.

- (b) Derive the expression for the moment of inertia of a homogeneous sphere of radius 'r' and mass density 'w' with reference to its diameter. [8+8]
6. (a) A train is uniformly accelerated and passes successive kilometer stones with velocities of 18 km/hr and 36 km/hr respectively. Calculate the velocity when it passes the third kilometer stone. Also find the time taken for each of the two intervals of one kilometer.
- (b) A ball projected vertically upwards attains a maximum height of 400 metres. Calculate the velocity of projection and compute the time of flight in air. At what altitude will this ball meet a second ball projected vertically upwards 4 seconds later with a speed of 120 metres per second? [8+8]
7. (a) A body weighing 20 N is projected up a 20° inclined plane with a velocity of 12 m/s, coefficient of friction is 0.15. Find
- The maximum distance S, that the body will move up the inclined plane
 - Velocity of the body when it returns to its original position.
- (b) Find the acceleration of the moving loads as shown in figure 7b. Take mass of P=120 kg and that of Q=80 Kg and coefficient of friction between surfaces of contact is 0.3. Also find the tension in the connecting string. [8+8]

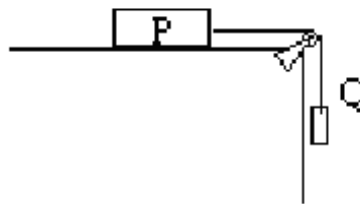

Figure 7b

8. (a) A homogeneous circular disk of radius 'r' and weight 'W' hangs in a vertical plane from a pin 'O' at its circumference. Find the period τ for small angles of swing in the plane of the disk
- (b) A slender wire 0.90 m long is bent in the form of a equilateral triangle and hangs from a pin at 'O' as shown in the figure8b. Determine the period τ for small amplitudes of swing in the plane of the figure. [16]

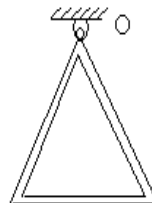

Figure 8b

II B.Tech I Semester Supplementary Examinations, November 2008
ENGINEERING MECHANICS
(Chemical Engineering)

Time: 3 hours

Max Marks: 80

Answer any FIVE Questions
 All Questions carry equal marks

1. (a) Explain various force systems with neat sketches.
- (b) A roller of radius $r = 0.3$ m and weight $Q = 2000$ N is to be pulled over a curb of height $h = 0.15$ m. by a horizontal force P applied to the end of a string wound around the circumference of the roller. Find the magnitude of P required to start the roller over the curb. As shown in the Figure 1b. [6+10]

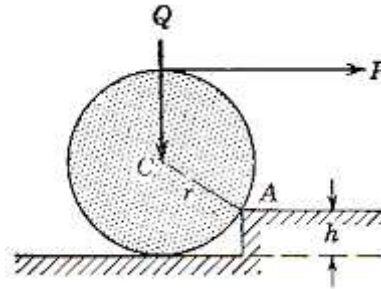

Figure 1b

2. (a) Explain the principles of operation of a screw jack with a neat sketch.
- (b) Outside diameter of a square threaded spindle of a screw Jack is 40 mm. The screw pitch is 10 mm. If the coefficient of friction between the screw and the nut is 0.15, neglecting friction between the nut and collar, determine
 - i. Force required to be applied at the screw to raise a load of 2000N
 - ii. The efficiency of screw jack
 - iii. Force required to be applied at pitch radius to lower the same load of 2000 N and
 - iv. Efficiency while lowering the load
 - v. What should be the pitch for the maximum efficiency of the screw? and
 - vi. What should be the value of the maximum efficiency? [6+10]
3. (a) Derive an expression for length of an open belt in standard form.
- (b) A belt is running over a pulley of diameter 1200 mm at 200 r.p.m. The angle of contact is 165° and coefficient of friction between the belt and pulley is 0.3. If the maximum tension in the belt is 3000 N, find the power transmitted by the belt. [6+10]
4. (a) Deduce an expression from first principle to determine the center of gravity of a right circular solid cone about its base.

- (b) Locate the centroid of the shaded area as shown in figure4b. [8+8]

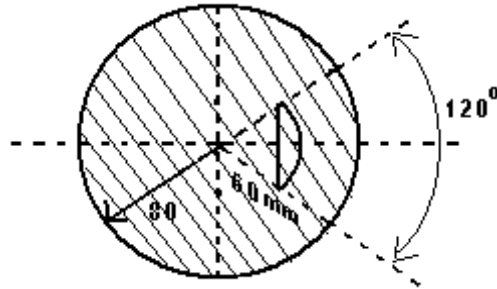

Figure 4b

5. Derive the expression for the moment of inertia of a cylinder length ' l ', radius ' r ' and density ' w ' about longitudinal centroidal axis and about the centroidal transverse axis. [16]
6. (a) A particle under a constant deceleration is moving in a straight line and covers a distance of 20 m in first two seconds and 40 m in the next 5 seconds. Calculate the distance it covers in the subsequent 3 seconds and the total distance covered, before it comes to rest.
- (b) Deduce the general expression to determine the maximum height and horizontal range of projectile. [8+8]
7. (a) A weight 'P' attached to the end of a flexible rope of diameter $d=5\text{mm}$, is raised vertically by winching the rope on a reel. The reel is turned uniformly at the rate of 2 revolutions per second. Find the tension in the rope. Neglect the inertia of the rope and the lateral motion of the weight 'P'. As shown in the Figure 7a.

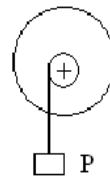

Figure 7a

- (b) A right circular cylinder of radius ' r ' and weight ' W ' is suspended by a cord that is wound around its surface. If the cylinder is allowed to fall, prove that the center of gravity 'C' will follow a vertical rectilinear path and find the acceleration ' a_c ' along this path. Determine also the tensile force ' S ' in the cord. As shown in the Figure 7b. [8+8]

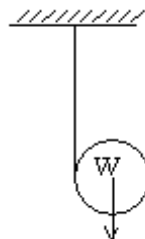

Figure 7b

8. The weight of an empty railway wagon is 240 KN on loading it with goods weighing 320KN, its springs get compressed by 80mm.
- (a) calculate its natural period of vibration when
- i. empty and
 - ii. loaded as above.
- (b) It is set into natural vibrations with amplitude of 100mm,when empty. Calculate the velocity when its displacement is 40mm from statical equilibrium position. [16]
